



Jeep Grand Cherokee WK2

MY2011-2013

Pre Runner/ Steel front bumper

IMPORTANT! – READ BEFORE INSTALLATION



- When installed in accordance with these instructions, the front protection bar does not affect the operation of the vehicles SRS airbags.
- This product must be installed exactly as per these instructions using only hardware supplied.
- Take a few moments to read instructions thoroughly before beginning work.
- In the event of damage to any component please contact OFFROAD ANIMAL to arrange repair/replacement of components.
- Do not use this product for any vehicle make or model other than that specified on these instructions.
- Do not remove labels from this product.
- This product and its fixings must not be modified in any way unless stated in these fitting instructions.
- The installation of this product is recommended for trained personnel.
- These instructions are correct at time of publication. OFFROAD ANIMAL cannot be held responsible for the impact of any changes subsequently made by the vehicle manufacturer. If you find something has changed please contact us to let us know!
- During installation it is the duty of the installer to check correct operation/clearances of all components.
- If Instructions are to be printed for reference in the workshop, it is recommended that they are printed in colour, for best legibility.
- Estimated install time: 2 hours

PARTS LISTING

IMPORTANT: Check all parts are present before beginning work! Contact OFFROAD ANIMAL if something is missing.

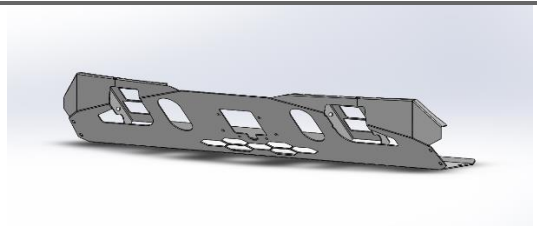
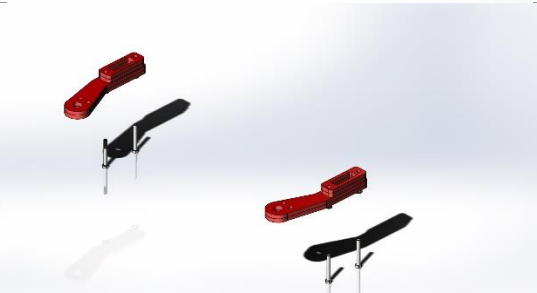
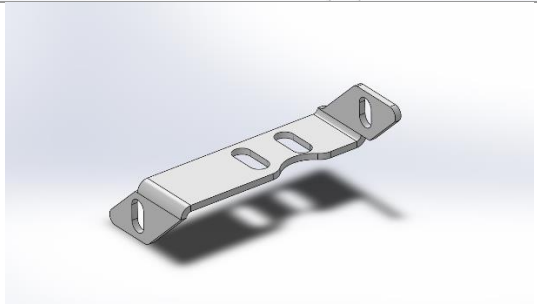
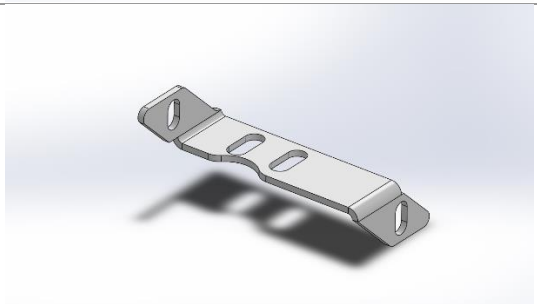
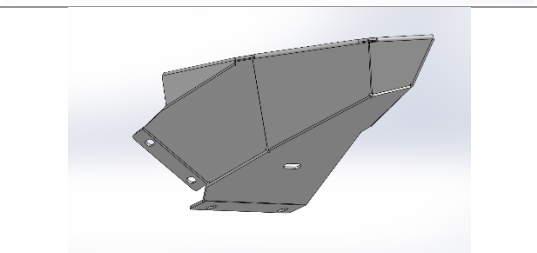
Main Parts – In the Box

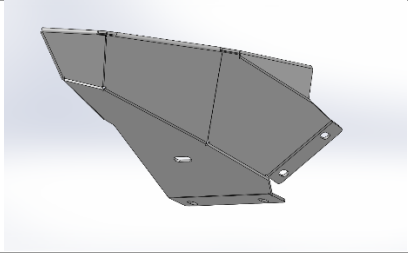
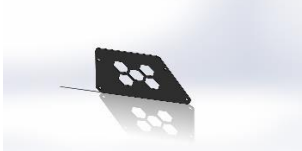
Qty	Part Number	Description	Image
1	PR-JGC-WK2-11-ASM1	Main Plate Pre-runner wk2	
1	RP-JGC-WK2-11-ASM0	Recovery Points Wk2 (some customers may already have these)	
1	B-0323L	Pre-Runner Mount LH	
1	B-0323R	Pre-Runner Mount RH	
1	B-0319L	Wk2 Pre-Runner wing LH	

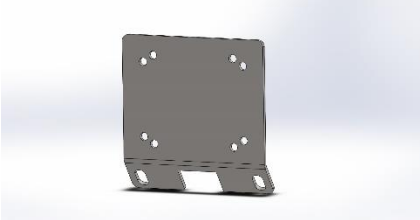
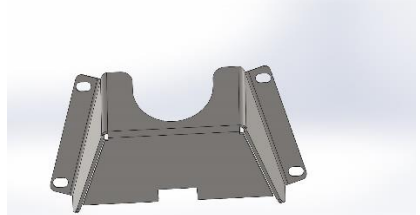
1	B-0319R	Wk2 Pre-Runner wing RH	
1	P-0021	Acc Cover	
1	B-0324L	Pre-Runner wing support LH	
1	B-0324R	Pre-Runner Wing support RH	
1	Optional extra ACC mount part B-0062	Acc mount wk2	
1	Optional extra ACC mount part B-0063	Acc cover	

Small Parts – Contained in Small Parts Kit Bag

Qty	Part Number	Description
10	M8 FW Black Zinc	M8 Flat washer black zinc plate
10	M8 x 20 BHCS BZ	M8 x 20 Button Head Cap Screw, Black Zinc
14	M8 FN	M8 Flange Nut
4	M6x16 BHCS BZ	M6 x 16 Button Head Cap Screw, Black Zinc
4	M6 FW BZ	M6 Flat washer, Black Zinc
4	M6 FN	M6 Flange Nut
8	M10 FN	M10 Flange Nut
8	M10 FW	M10 Flat Washer

4	M10x30	M10 x 30 Hex Bolt ZP
4	M10 x 45	M10 x 45 Hex Bolt, Zinc Plate
1	OFA-LOGO	OFFROAD ANIMAL METAL LOGO
1	Pinch Weld 2M	Pinch Weld Black 14mm x 9mm x 2M
4	M5 x 30 pan	M5 x 30 Pan head screw zinc Optional extra part
2	M8 x 30	M8 x 30 Hex zinc Optional extra part
2	M8 FW	M8 Flat washer Optional extra part
2	M8 FN	M8 Flange nut Optional extra part

TOOLS REQUIRED

The following tools will be required to install the product.

Hand Tools	Power Tools	Workshop Equipment
10mm Spanner 13mm Spanner 16mm Spanner 4mm Allen Key 5mm Allen Key 10mm Socket 13mm Socket 16mm Socket Ratcheting Socket Wrench Flat head screw driver or Pry Tool Side Cutters Phillips head screw driver	None	None

GENERAL WARNINGS

Take Care not to lose factory hardware, as some will be reused

Take care not to damage parking sensors, They may be disturbed by the new bumper. Sorry it's their position and this can't be helped with this new bumper.

If ACC radar is not working as it should, stand side on the vehicle and see which way it's pointing. If pointing up or down adjust screws so it's pointing straight ahead.



1. First step is to remove the lower air damn fascia. To do this climb under your Jeep and remove all 5 quarter turn clips by hand. Two are tucked up high in each corner and 3 in the middle
2. Once they are removed pull the entire lower air damn away from Jeep by hand. You will not be reusing this part

TOOLS REQUIRED

None

FASTENERS

Retain only if you wish to refit later

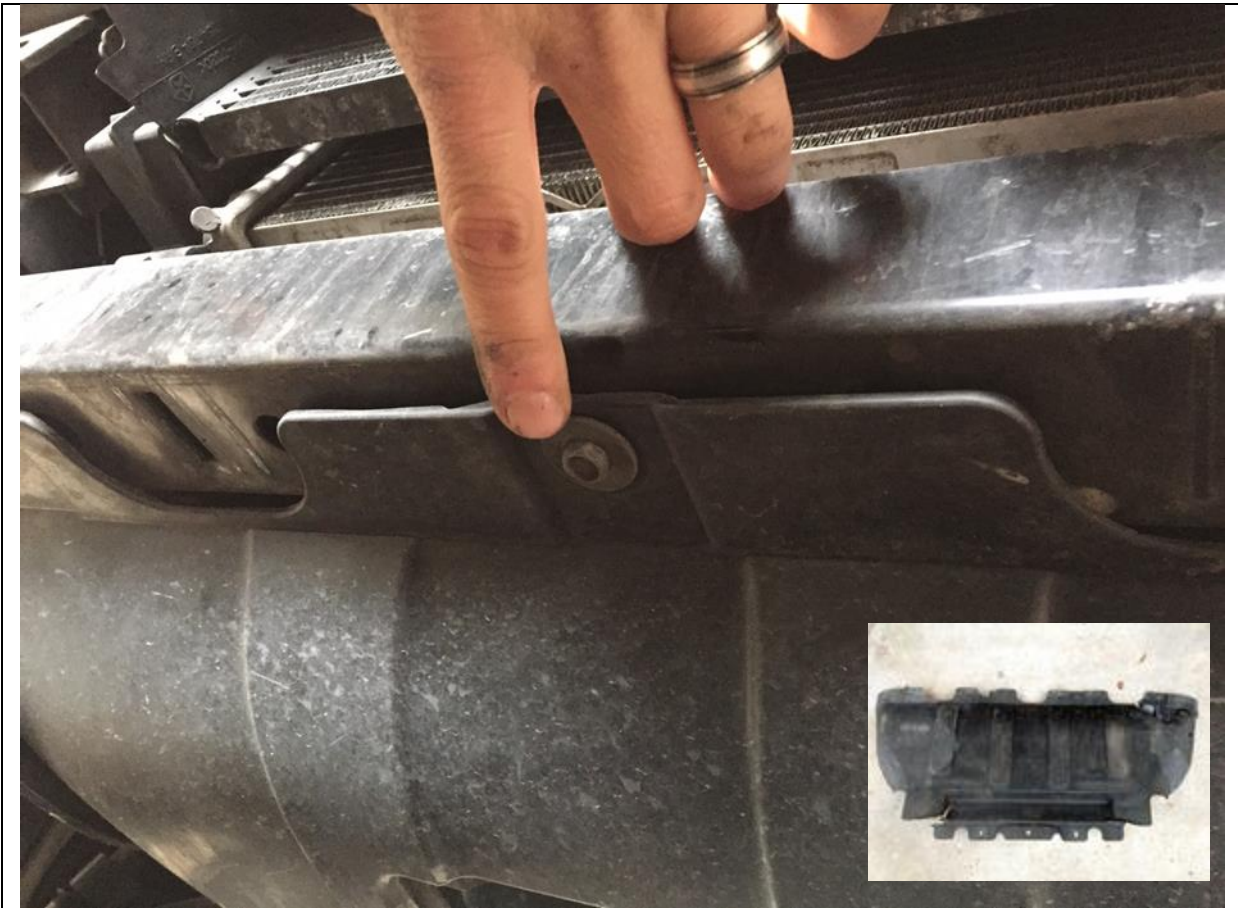

3. Remove factory Lower Radiator Cover. 3x M6 bolts on front and 2x M8 bolts on back. Use 10mm socket or spanner for front and 13mm for rear

TOOLS REQUIRED

10mm Socket or Spanner
13mm Socket or Spanner

FASTENERS

Retain for reuse



4. Remove factory tie down and or tow points

TOOLS REQUIRED

Socket set

FASTENERS

Discard fasteners



5. Stack Offroad Animal Tow points together as shown with M10 bolts and M10 flat washers.

TOOLS REQUIRED

FASTENERS

- M10x80 Hex bolts (4)
- M10 Flat Washers (4)



6. Fit Offroad Animal Tow points as shown on LH and RH side with M10x80 bolts directly into frame of Jeep. Torque down bolts. Be aware if fitting a nudge bar you may need to later loosen these bolts to realign these tow points to suit the nudge bar.

TOOLS REQUIRED

**16mm or 17mm Socket or
Spanner**

FASTENERS

M10 x 80 (4)
M10 Flat washers (4)



- 7. If Adaptive cruise control is fitted, unplug loom and pull sensor off posts. If you do not have ACC, skip this step
- 8. Remove bracket

TOOLS REQUIRED

8mm socket

FASTENERS



9. Fit side support bars as shown on both sides.
10. Remove lower factory bolt, place bracket on and reuse factory bolt

TOOLS REQUIRED

13mm spanner or socket

FASTENERS

Reuse Factory hardware



11. Fit pinch weld to top edge of main plate and wings

TOOLS REQUIRED

FASTENERS



12. Trim edges of pinch weld at edge of plate

TOOLS REQUIRED
Side cutters

FASTENERS



13. Fit Pre runner mounts as shown with M10 x 30 bolts, washers and flange nuts

TOOLS REQUIRED

16 or 17mm Spanner and or socket

FASTENERS

M10 x 30 (4)
M10 FW (4)
M10 FN (4)



14. Fit Pre Runner Upper Mounts to top of Tow points. Secure to Main plate M10 x 45 Bolts, flat washers and Flange nuts as shown.
15. Repeat for other side
16. Position plate to sit just in front of factory bumper and torque down bolts. It's fine if it touches factory bumper with pinch weld.

TOOLS REQUIRED

16mm or 17mm spanner and socket

FASTENERS

M10 x 45 Hex Bolt (4)
M10 FW (4)
M10 FN (4)



17. Using the factory M6 bolts secure through the bottom of the Pre runner centre plate

TOOLS REQUIRED

10mm socket or spanner

FASTENERS

Factory M6 screws



18. Fit wings as shown, using M8 hardware. Reach in from behind bumper to fit nut on back
19. Repeat for other side

TOOLS REQUIRED
5mm allen key

FASTENERS

M8 x 20 BHCS BZ (4)
M8 FW BZ (4)
M8 flange nut (4)



20. Position the wings to have the smallest gap possible between wings and centre. Torque up bolts

TOOLS REQUIRED

5mm Allen key

FASTENERS



- 21. Fit Bolt through wing into support bracket
- 22. Repeat for other side

TOOLS REQUIRED

5mm Allen Key

FASTENERS

**M8 x 20 BHCS black (2)
M8 flat washer (2)
M8 flange nut (2)**

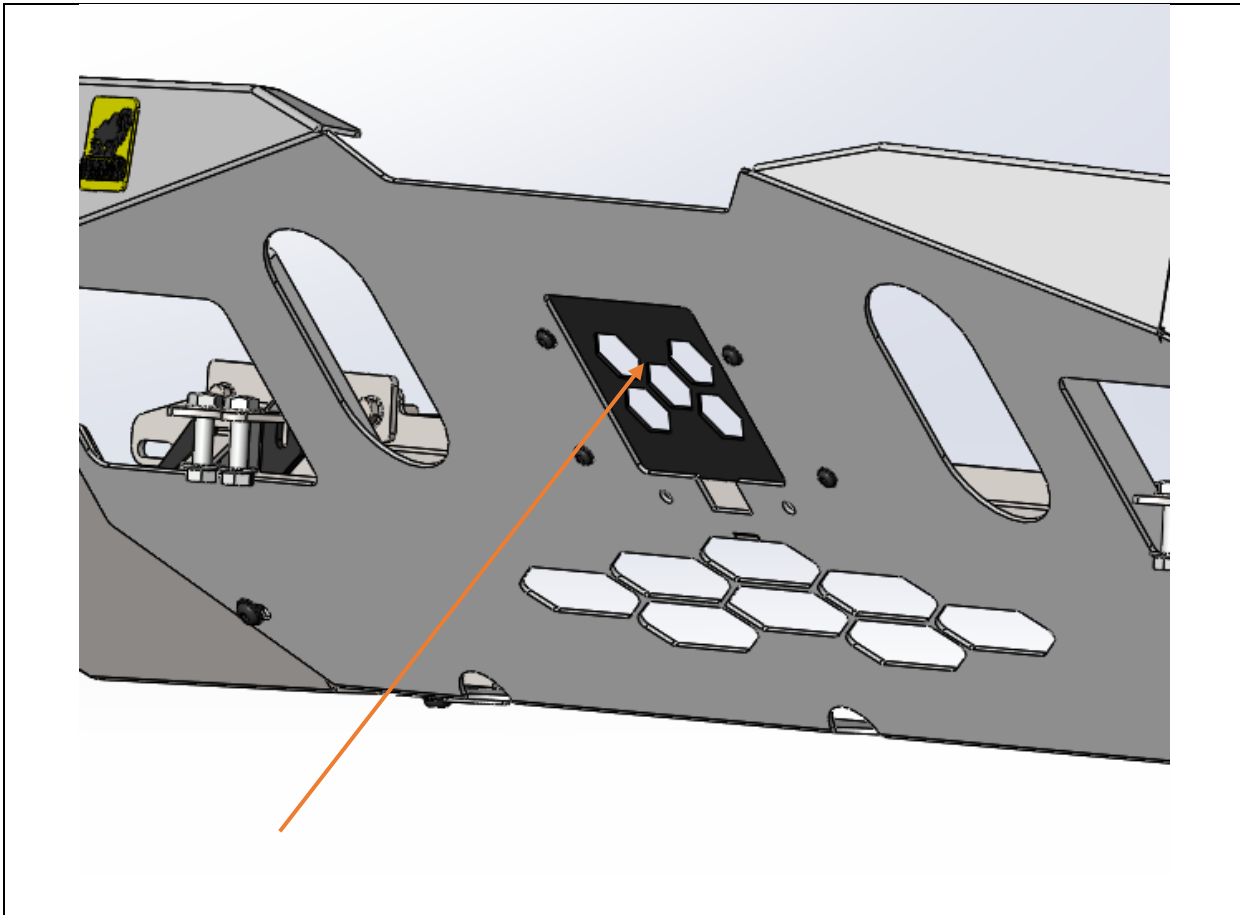

- 23. If no Adaptive cruise control is fitted, then fit ACC cover plate with M8 x 16 button head cap screws (black zinc), flat washers and flange nuts
- 24. Otherwise skip to next step

TOOLS REQUIRED

4mm Allen Key

FASTENERS

M6 x 16 BHCS black (4)
M6 flat washer black (4)
M6 flange nut (4)

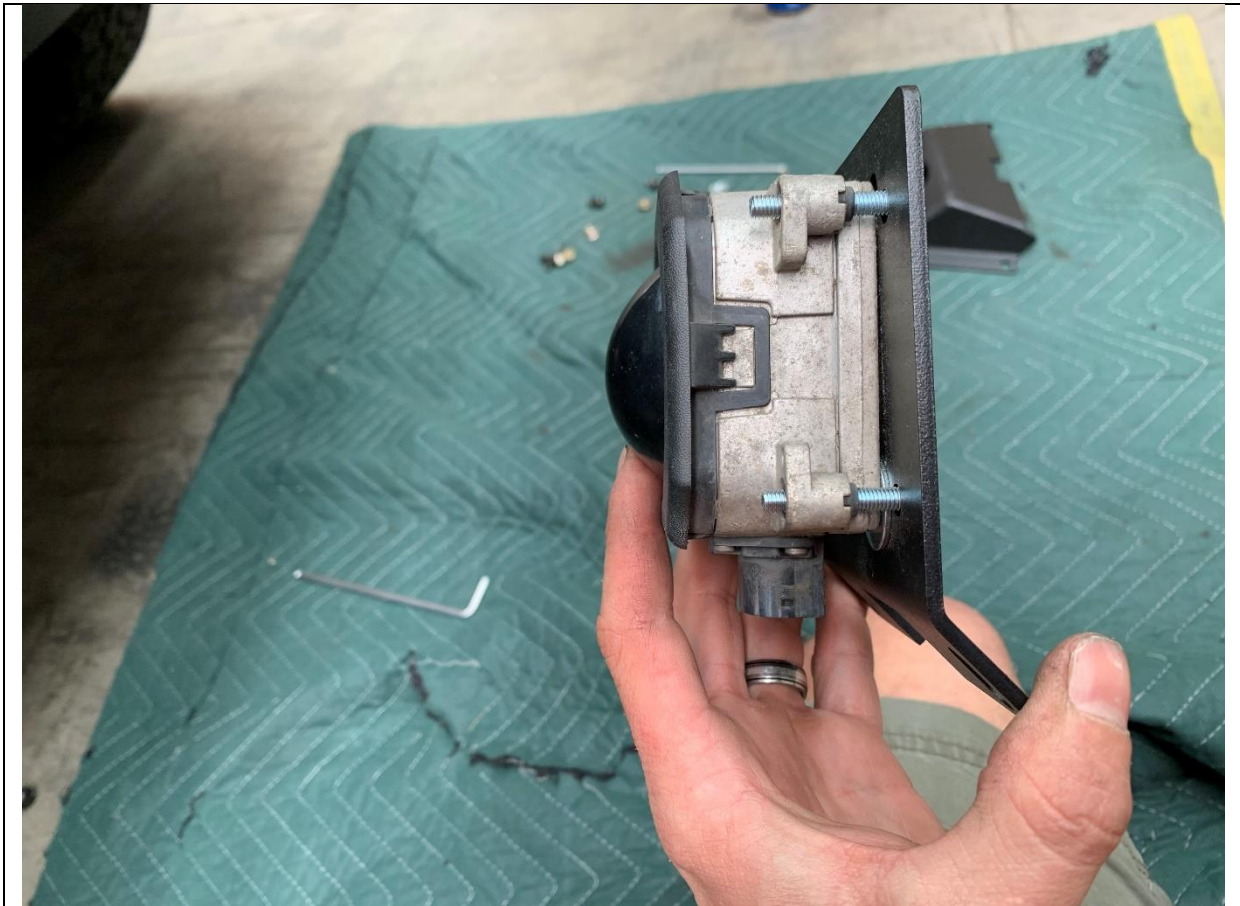

- 25. If you have Adaptive cruise control you will need optional Offroad Animal Part “ PR-JGC-WK2-14-ASM3”
- 26. Fit Radar sensor to Acc Mount Wk2 plate with supplied M5 x 30 pan head screws in optional kit
- 27. Feed Sensor and plate through Main plate and secure to main plate with supplied M8 x 30 Hex bolts, flat washers and flange bolts from optional kit
- 28. Ensure sensor is facing forward and straight ahead. If pointing down or up it will not function properly. Adjust till it's pointing straight ahead. A test drive can confirm this.

TOOLS REQUIRED

**Phillips head screw driver
13mm spanner or socket**

FASTENERS

**M5 x 30 Pan head (4)
M8 x 30 Hex bolt (4)
M8 flat washer (4)
M8 flange nut (4)**



29. Torque up all front bolts

TOOLS REQUIRED
5mm Allen key

FASTENERS



- 30. Fit logo plate to bumper. If fitting nudge bar hold off until that is on before doing this step.
- 31. You're done, enjoy the coolness that is your Jeep now.

TOOLS REQUIRED

FASTENERS

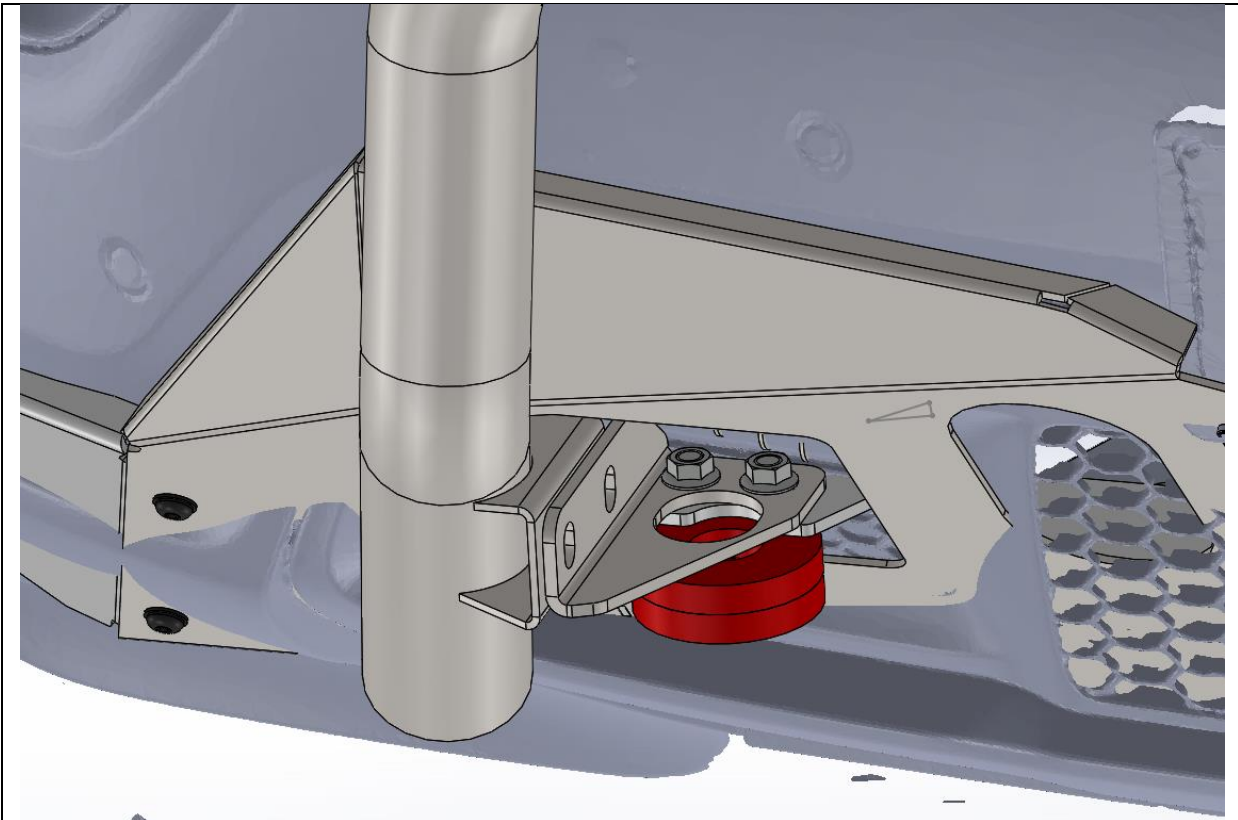

- 32. If fitting and Offroad Animal Nudge bar you can do so now as shown with bracket B-0325R and B-0325L
- 33. **Note you must use a soft shackle or D shackle instead of a bow shackle if running the nudge bar**
- 34. **Bracket goes on top of the pre runner**

TOOLS REQUIRED
17mm Spanner or socket

FASTENERS
Supplied with Nudge bar
M10x25 Hex Bolt (4)
M10 FW (4)
M10 FN (4)